



IETF

Making the Internet Work Better

Андрей Робачевский

andrei@ripe.net

Internet Engineering Task Force



- Development of open, consensus-based Internet standards
- The mission of the IETF is to produce high quality, relevant technical and engineering documents that influence the way people design, use, and manage the Internet in such a way as to make the Internet work better. These documents include protocol standards, best current practices, and informational documents of various kinds. [RFC 3935]

Internet Engineering Task Force



- Разработка открытых стандартов Интернета на основе консенсуса
- Миссией IETF является создание инженерно-технических спецификаций высокого качества, с помощью которых проектирование, использование и управление Интернетом делает его работу еще лучше. Эти спецификации включают стандарты протоколов, описание лучшей текущей практики, а также информационные документы различного рода. [RFC 3935]

IETF standards make the Internet work



- TCP/IP
 - IPv4 ([RFC791](#)) and IPv6 ([RFC2460](#)...)
 - TCP ([RFC675](#)...) and UDP ([RFC768](#))
- E-Mail
 - SMTP ([RFC5321](#))
- Network and Routing
 - MPLS ([RFC3031](#)) and BGP ([RFC4271](#))
- ...
- DNS ([RFC1034,1035](#)...)
- Web
 - HTTP ([RFC2616](#)...)
- VoIP
 - SIP ([RFC3261](#)...) and RTP ([RFC3550](#)...)
- ...

How the IETF works



- High-quality standards
 - Experts, not organisations
 - Open and consensus based
- Areas and Working Groups
 - Mailinglists with open membership
 - Most of the work is done on-line
 - 3 face-to-face meetings with remote participation
- Working specifications and standards freely available
- Maintenance responsibility
 - Standards track

Standards process

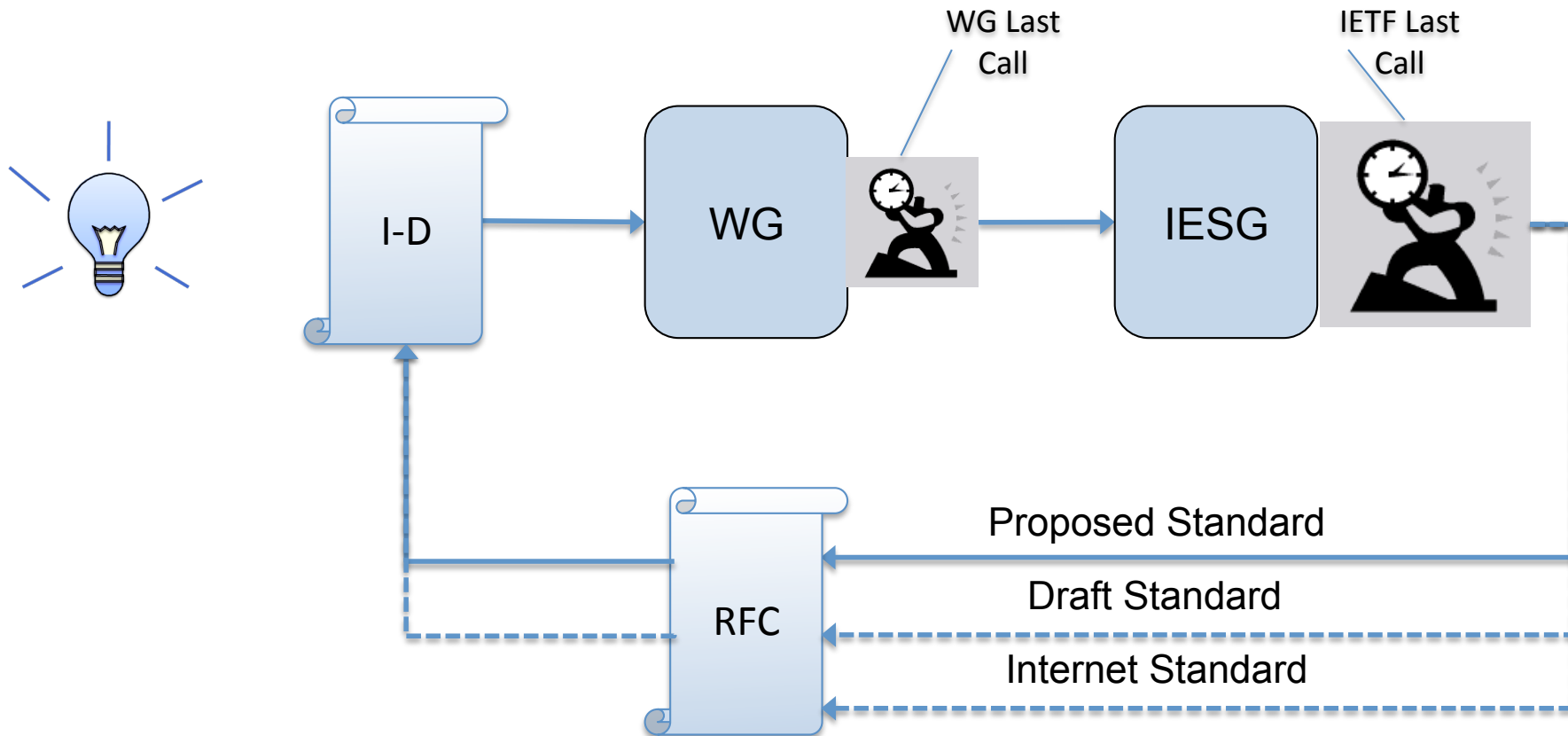

IETF at a glance

- 1000-2000 people at 3 meetings/year
 - From 40-50 different countries
 - Many, many more on mailing lists
- ~120 Working Groups (WGs)
 - ~2 WG chairs each
- 8 Areas with 15 Area Directors (ADs)
- More than 5500 RFCs published
 - Internet Standards and informational documents
- More than 50000 Internet Draft revisions submitted

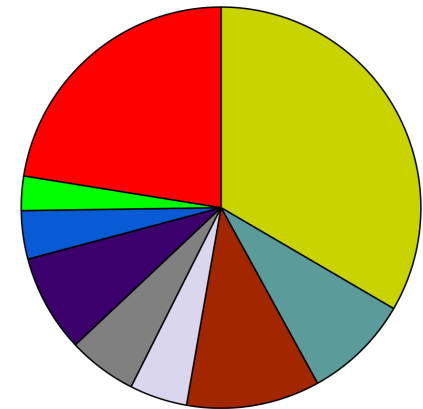

Participants at IETF-78
Maastricht, July 2010
1153 total, 53 countries

Areas and WGs



Internet Architecture Board (IAB)

asrg
cfrg
dtmrg
hiprg
iccr
moboopts
nmrg
p2prg
pkng
rrg
samrg
tmrg
vnrg

Internet Research Task Force

alto
calsify
core
decade
eai
httpbis
httpstate
hybi
iri
marf
morg
oauth
sieve
vcardsdav
vwrap
yam

Applications Area

behave
dccc
fecframe
ippm
ledbat
mptcp
nfsv4
nsis
pcn
ppcp
rmt
storm
tcpm
tsvrg

Transport Area

dkim
emu
hokey
ipsecme
isms
keyprov
kitten
krb-wg
ltans
msec
nea
pkix
sasl
smime
syslog
tls

Security Area

bfd
ccamp
forces
idr
isis
karp
l2vpn
l3vpn
manet
mpls
ospf
pce
pim
pwe3
roll
rtgwg
sidr
vrrp

Routing Area

adslmib
bmwg
dime
dnsop
grow
ipfix
mboned
netconf
netmod
opsawg
opsec
pmol
radext
v6ops

O&M Area

avt
bliss
codec
dispatch
drinks
ecrit
enum
geopriv
martini
mediactrl
mmusic
p2psip
simple
sipclf
sipcore
siprec
soc
speechsc
speermint
xcon
xmpp

RAI Area

16ng
6lowpan
6man
ancp
autoconf
csi
dhc
dnsect
hip
intarea
ipdvb
l2tptext
lisp
mext
mif
mip4
mipshop
multimob
netext
netlmm
ntp
pppext
savi
shim6
softwire
tictoc
trill

Internet Area

GENERAL AREA

Internet Engineering Steering Group (IESG)

IETF Universe

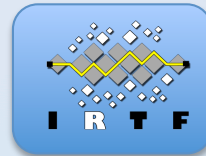

RFC Editor

IESG
Area Directors

IETF Secretariat

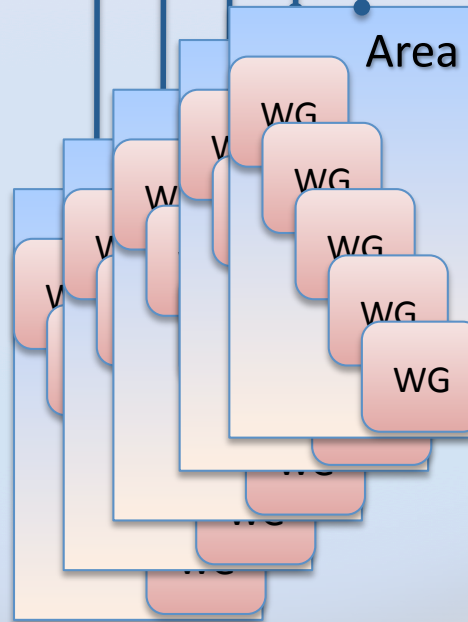
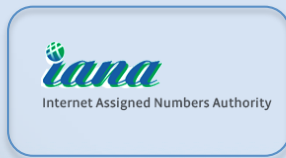

IASA

IETF Trust

IETF and other organisations

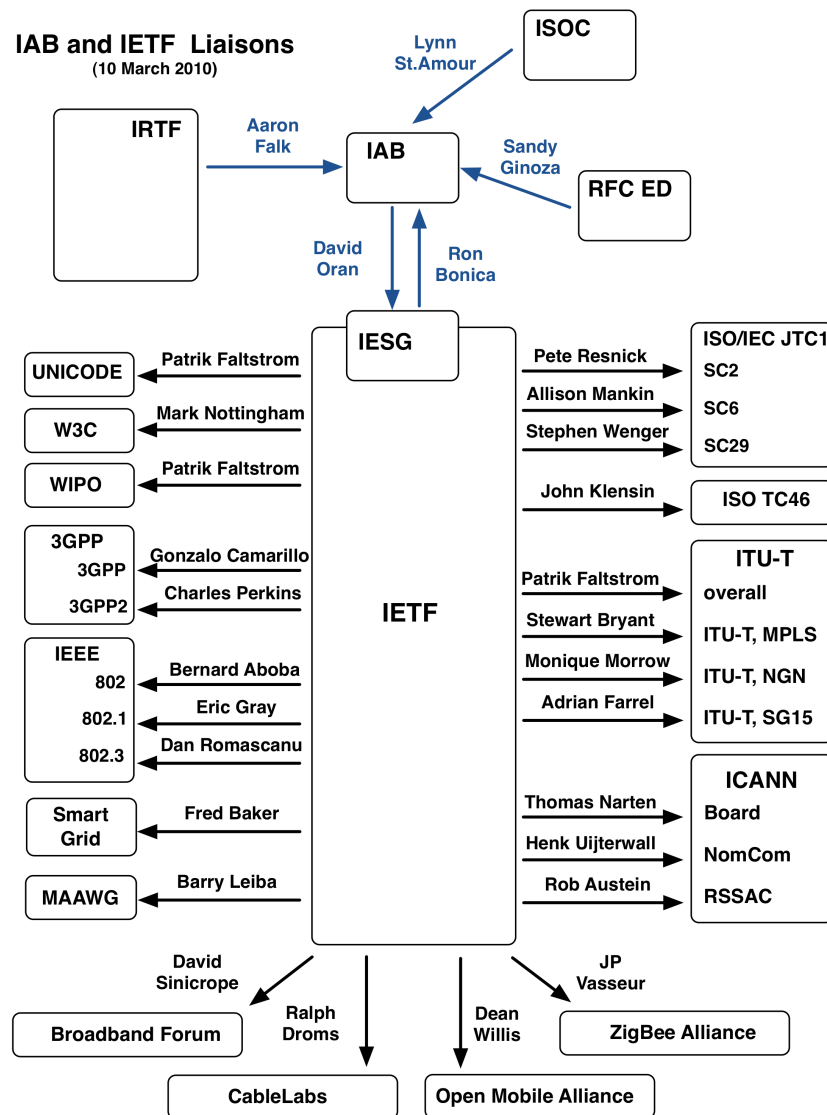

IPv6 work in the IETF



- **behave**: Deals defines translation mechanisms to connect IPv4 to IPv6 networks
- **softwire**: Provides tunneling mechanisms to connect islands of address families (see RFC4925)
- **6man**: Fixes 'bugs' in the IPv6 specification
- **v6ops**: Operational guidance and more
- **savi**: improvement of validation of sources of IP traffic on a link (v4 and v6)
- **csi**: Reviewing secure neighbor discovery (SEND)

Routing Security



- **sidr**: Secure inter-domain routing
 - Define an extendable routing security framework
 - Use of resource certificates to improve security
- ROA - Route Origin Authorizations
- Integration with BGP decision process
 - A degree of preference for the route
 - “Valid”->“Unknown”->“Invalid”
 - SHOULD exclude “Invalid” routes
 - “Invalid” indicates a decision of the resource holder

Internationalisation (i18n) Internationalised Domain Names



- First attempt 2003
 - **idn** WG - IDNA2003
- **idna**
 - IDNA2008 – approved 2010
 - extended repertoire of allowed characters
 - removed U-label – A-label mapping ambiguity
 - removed dependency on version of Unicode
- First Internationalised TLDs
 - . PΦ, مصر, السعودية, امارات, .中国, .中國, .香港, .台灣, .台湾

Internationalisation (i18n) Email Address Internationalization

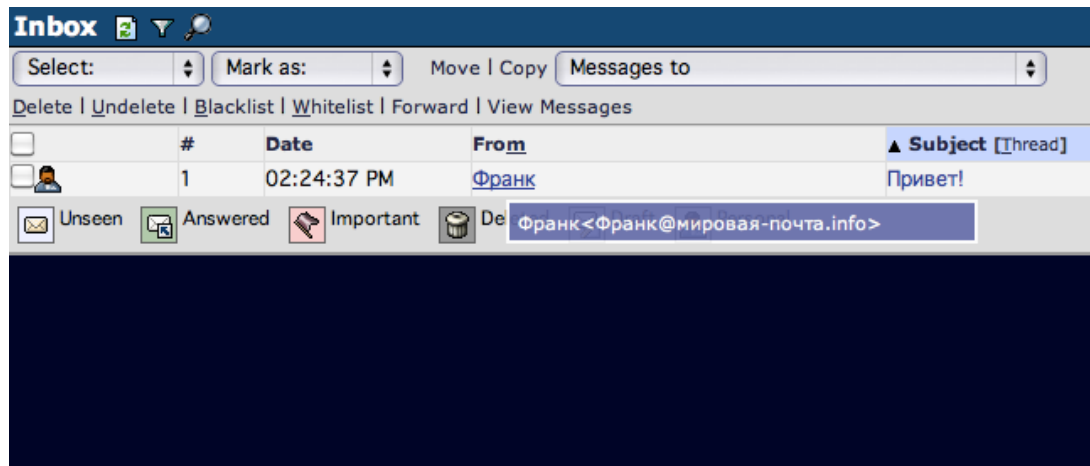

Date: Thu, 23 Sep 2010 20:24:37 +0200 [02:24:37 PM EDT]
From: Франк <Франк@мировая-почта.info>
To: <Миранда@мировая-почта.info>
Subject: Привет!
Headers: [Show All Headers](#)

Привет Миранда!

This message was sent using Afilias IDN Mail

Internationalisation (i18n) Email Address Internationalization



- **eai**: first attempt
 - UTF-8 in local and domain parts (utf8@utf8)
 - New SMTP extension
 - In-transit downgrading for backwards compatibility
 - A series of experimental RFCs
- **eai**: rechartered at IETF-77 (March 2010)
 - standardise a simplified model
 - no fallback
 - finish before end 2011

Internationalisation (i18n) Email Address Internationalization



- Tracking implementations
 - interop: CNNIC, JPRS, NIDA, TWNIC, Afilias
- Afilias global-mail prototype
 - <http://global-email.info/>
- ICANN's E-mail test
 - http://idn.icann.org/E-mail_test

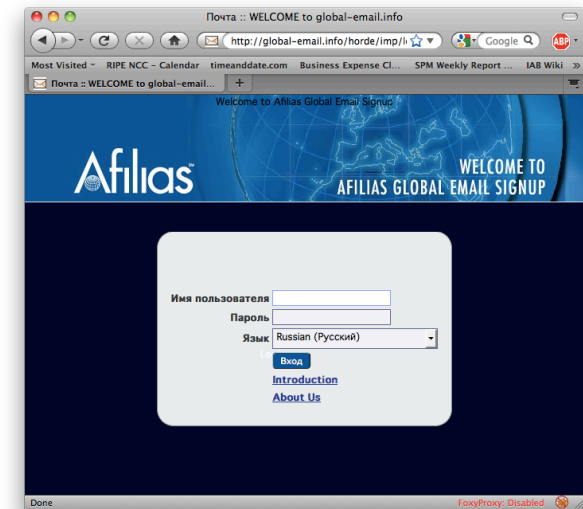

Summary



- IETF makes the Internet work better
 - Fundamental role in Internet administration
- Your participation is critical to the success of the IETF
 - International scope, local relevance
- Open, inclusive, well established structure
 - evolving together with the Internet
- More information
 - www.ietf.org



Thank You!